

CAJA PARA REGISTRO DE DESAGÜE CONVENCIONAL

NTP 334.081

NTP 350.085



CAJA PARA REGISTRO

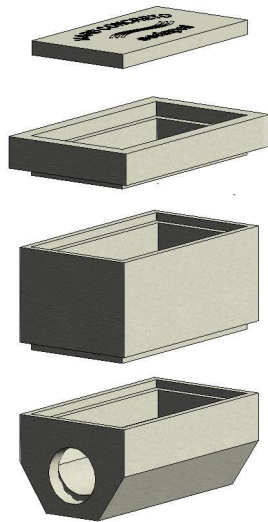

VISTA POR SEPARADO

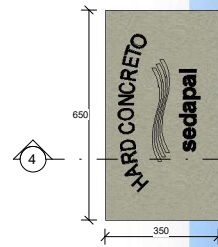

TAPA
1:10

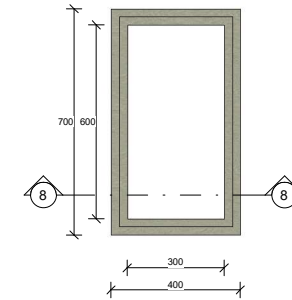

INTERMEDIO
1:10

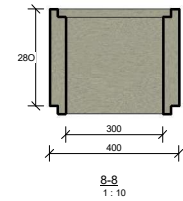

8-8
1:10

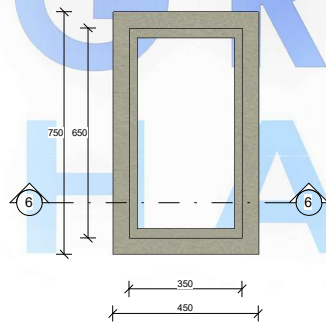

MARCO
1:10

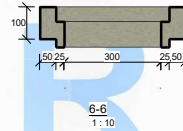

6-6
1:10

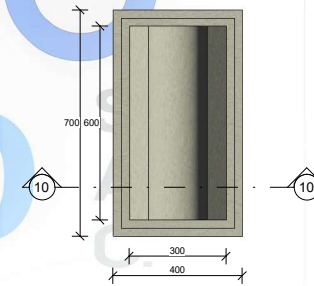

BASE
1:10

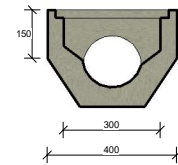

10-10
1:10

| | | | | | | | | | |
|-----------------|--|-----------------|------------------------|---------|-------------------------|--|-----------|--|---------|
| Cemento: | Bolsas/Und: | Tipo de Mezcla: | 210 kg/cm ² | Fv: | 4200 kg/cm ² | | | | |
| Denominación: | CAJA PARA REGISTRO DE DESAGÜE CONVENCIONAL | | | | | | | | |
| Producto Final: | | | | | | | | | |
| Dibujó: | | Disenó: | | Código: | | | Revisado: | | Escala: |