

CAJA PARA REGISTRO DE DESAGÜE CONDOMINIAL

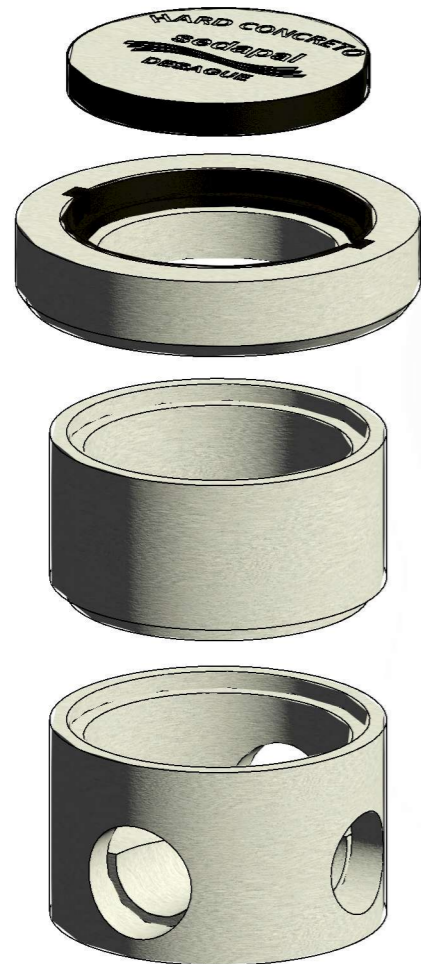

1 CAJA CONDOMINIAL
A103



2 COMPONENTES SEPARADOS
A103

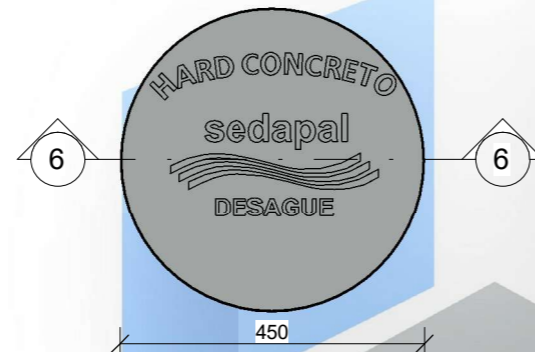

3 TAPA
A103 1:10

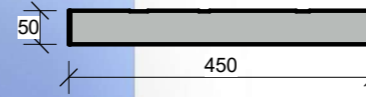

6 6-6
A103 1:10

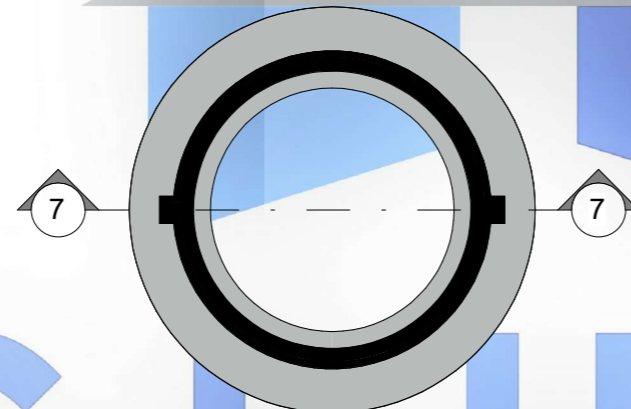

4 ANILLO SUPERIOR
A103 1:10

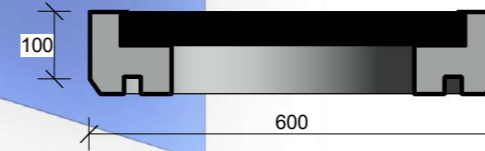

7 7-7
A103 1:10

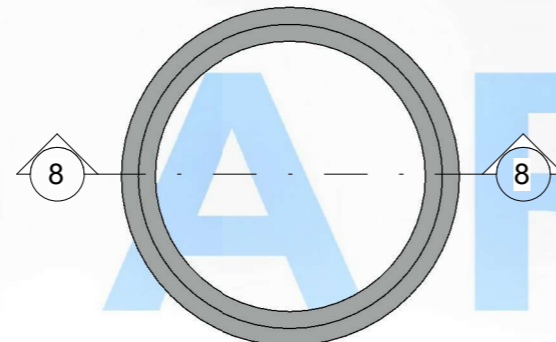

5 ANILLO INTERMEDIO
A103 1:10

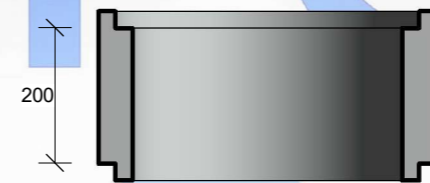

8 8-8
A103 1:10

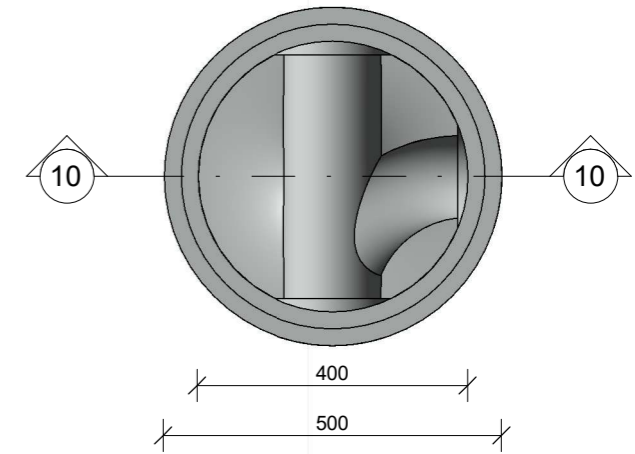

9 BASE
A103 1:10

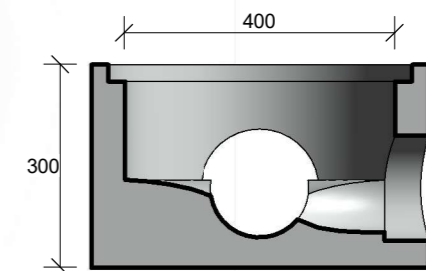

10 10-10
A103 1:10

Cemento: Bolsas/Und. Tipo de Mezcla: 210 kg/cm² fy: 4200 kg/cm²

Denominación: CAJA PARA REGISTRO DE DESAGÜE CONDOMINIAL

Producto Final:

Dibujado:
Diseñado:
Revisado:

Código:

Revisado: Escala:

